

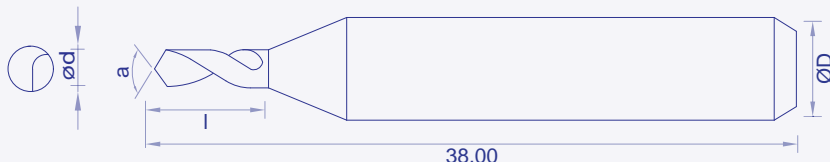

D : Ø 1/8" (3.175 mm) Common Shank

On Request Shank Dia 3mm



### MICRO VIA DRILL D550

d	mm	l	mm
0.075		0.80	
0.100		0.80	
0.150		2.00	
0.200		2.50	
0.300		2.50	

On request : Inch sizes / Special dimensions

\* : Non stock items / Articles

D : Ø 1/8" (3.175 mm) Common Shank

On Request Shank Dia 3mm

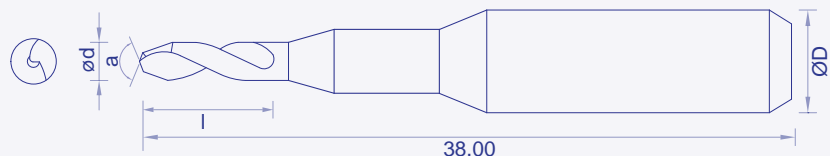

### TAPERED MICRO VIA DRILL D551

d	mm	l	mm
0.075		0.50	
0.120		0.50	
0.150		0.50	
0.200		1.00	
0.250		1.00	
0.400		2.50	

On request : Inch sizes / Special dimensions

\* : Non stock items / Articles



Connecting of inner layers by drilling through micro via

#### MAX. DRILLING DEPTH

For dia 0.075mm is 75µm

For dia 0.40mm is 400µm

Point Angle a



#### APPLICATION

For making micro via holes(Blind holes).  
Drilling of inner layers and foils.

#### ADVANTAGES

Excellent hole quality.  
High positional accuracy.

#### PACKING

10 tools per pack.  
50 tools per pack.

SCAN TO ORDER





D : Ø 1/8" (3.175 mm) Common Shank

On Request Shank Dia 3mm

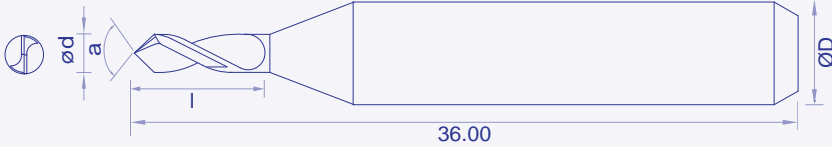

### ISOLATION PATH CUTTER

d mm	l mm	a
0.75	2.10	30°
0.75	2.10	60°
0.75	2.10	90°
1.60	3.80	90°

On request : Inch sizes / Special dimensions

\* : Non stock items / Articles

D : Ø 1/8" (3.175 mm) Common Shank

On Request Shank Dia 3mm

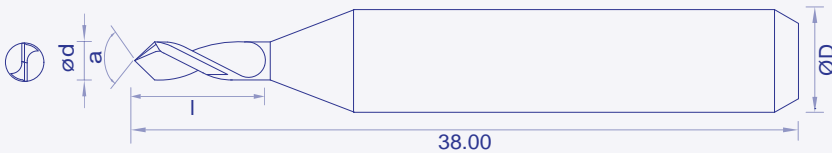

### ISOLATION PATH CUTTER

d mm	l mm	a
0.75	2.10	30°
0.75	2.10	60°
0.75	2.10	90°
1.60	3.80	90°

On request : Inch sizes / Special dimensions

\* : Non stock items / Articles

Article G842  
Point Angle a

Article G843  
Point Angle a

Article G844  
Point Angle a

#### APPLICATION

Used for isolation path cutting in prototype PCB for R&D and training institutions.

Used for engraving applications.

#### PACKING

10 tools per pack.  
50 tools per pack.

SCAN TO ORDER



QUALITY • PRECISION • CONSISTENCY

www.indspinx.com  
+91 1792 232860 / 232960  
customerfocus@indspinx.com



**V GROVE ROUTER G846**

D : Ø 1/8" (3.175 mm) Common Shank

On Request Shank Dia 3mm

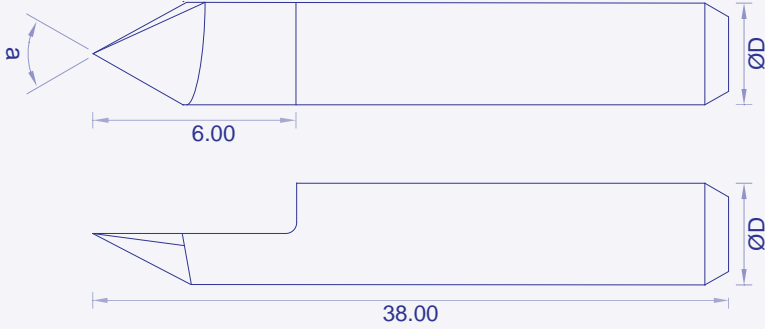

a

30°

45°\*

60°\*

90°\*

On request : Inch sizes / Special dimensions

\* : Non stock items / Articles

**V SCORE ROUTER HELICAL G845**

D : Ø 1/8" (3.175 mm) Common Shank

On Request Shank Dia 3mm

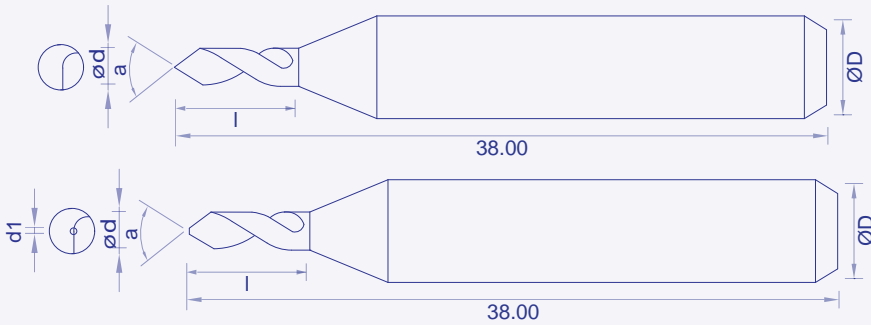

d mm	a	d1 mm
2.00	30°	0.25
2.00	30°	-
2.00	45°	-
2.00	60°	-
2.40	60°	-
3.175	90° / 120°	-
3.175	140°	-

On request : Inch sizes / Special dimensions

\* : Non stock items / Articles

**RECOMMENDED PARAMETERS**

LIP ANGLE	SPEED	XY FEED
a	RPM	m/min
30°	50,000 - 60,000	0.60 - 1.20
45°	48,000 - 58,000	0.70 - 1.30
60°	45,000 - 55,000	0.80 - 1.50
90°	40,000 - 50,000	1.00 - 1.80

Tabulated parameters provide guidelines which acts as starting points for optimising speeds and feeds at the user's end.

**APPLICATION**

- V scoring of PCBs.
- Routing of insulation path in prototypes.
- Partial removal of solder mask.

**CAUTIONS**

- Ensure efficient swarf evacuation.
- Adequate foot pressure.
- Ensure proper clamping of PCBs.

**PACKING**

- 10 tools per pack.
- 50 tools per pack.

SCAN TO ORDER



QUALITY • PRECISION • CONSISTENCY

www.indspinx.com  
+91 1792 232860 / 232960  
customerfocus@indspinx.com



## PCB STACK HOLE DRILL D835

D : Ø 1/8" (3.175 mm) Common Shank

On Request Shank Dia 3mm

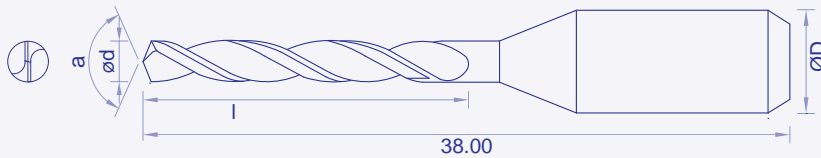

d mm	l mm	L mm
3.150	20.00	50.00
3.175	20.00	50.00

On request : Inch sizes / Special dimensions

\* : Non stock items / Articles

### APPLICATION

For PCB stack pinning.

### CAUTIONS

Ensure efficient swarf evacuation.  
Good collet condition.

### PACKING

10 tools per pack.  
50 tools per pack.

D : Ø 1/8" (3.175 mm) Common Shank

On Request Shank Dia 3mm

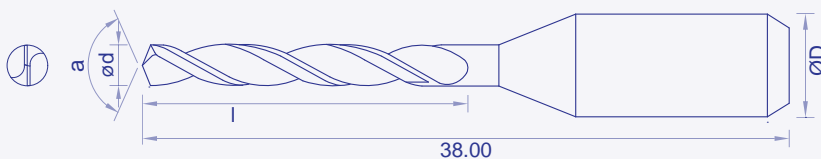

## PCB FIXTURE DRILL D835

d mm	l mm	L mm
0.70 - 1.00	12.00 / 16.00 / 18.00	38.00
1.05 - 1.50	12.00 / 16.00 / 18.00	38.00
1.55 - 2.00	12.00 / 16.00 / 18.00	38.00
2.05 - 3.00	12.00 / 16.00 / 18.00	38.00
3.05 - 3.10	12.00 / 16.00 / 18.00	38.00
3.150	12.00 / 16.00 / 18.00	38.00
3.175	12.00 / 16.00 / 18.00	38.00

On request : Inch sizes / Special dimensions

\* : Non stock items / Articles

### APPLICATION

For PCB fixture drilling.

### CAUTIONS

Ensure efficient swarf evacuation.  
Good collet condition.

### PACKING

10 tools per pack.  
50 tools per pack.

SCAN TO ORDER





## CHAMFERING CUTTER C681

D : Ø 1/8" (3.175 mm) Common Shank

On Request Shank Dia 3mm

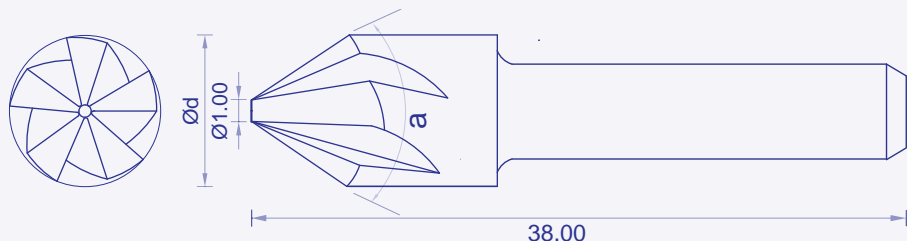

d	mm	l	mm
6.00 / 6.35		60°	
6.00 / 6.35		75°	
6.00 / 6.35		90°	
6.00 / 6.35		120°	
6.00 / 6.35		140°	

On request : Inch sizes / Special dimensions

\* : Non stock items / Articles

### APPLICATION

For countersinking in FR-4,Plastics,Inox Stainless steel,MS,Brass,Copper and Aluminium.

### ADVANTAGES

Optimally suitable for chamfering and deburring application.

### PACKING

10 tools per pack.  
50 tools per pack.

D : Ø 1/8" (3.175 mm) Common Shank

On Request Shank Dia 3mm

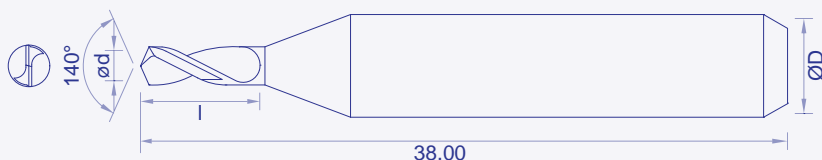

## CENTRE DRILL D580

d	mm	l	mm
0.30		2.50	
0.35		2.50	
0.40		2.50	
0.45		3.00	
0.50		3.00	
0.55		3.00	
0.60		3.00	

On request : Inch sizes / Special dimensions

\* : Non stock items / Articles

### APPLICATION

Drilling of inner layers of via holes.  
Registration holes for laser

### ADVANTAGES

High positional accuracy.

### PACKING

10 tools per pack.  
50 per pack.

### ALSO AVAILABLE

Counter sunk Drill



V Circular Cutter



SCAN TO ORDER



QUALITY • PRECISION • CONSISTENCY

www.ind sphinx.com  
+91 1792 232860 / 232960  
customerfocus@indsphinx.com